

PANTHER 5 x 8

STANDARD MACHINE

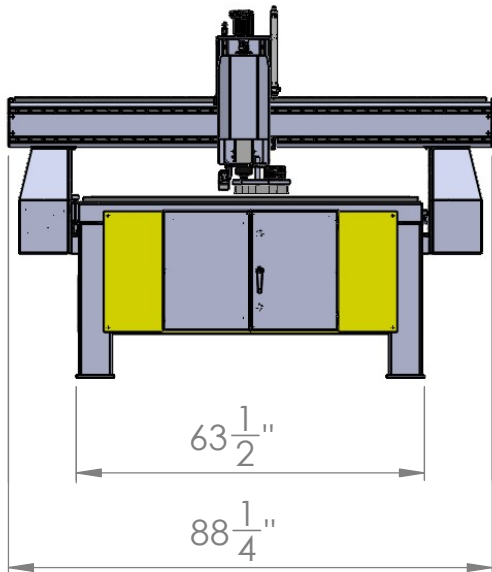

ATC MACHINE

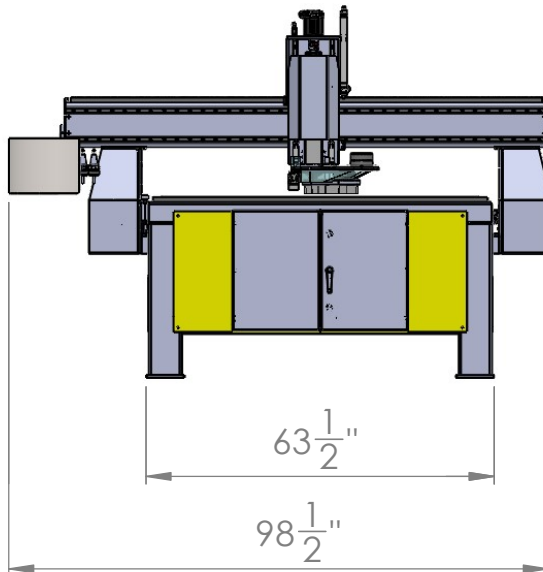

RECOIL MACHINE

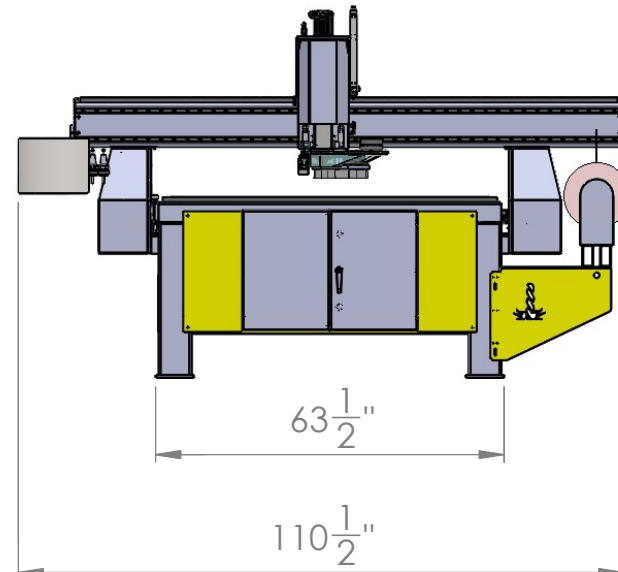

ATC + T2T3 MACHINE

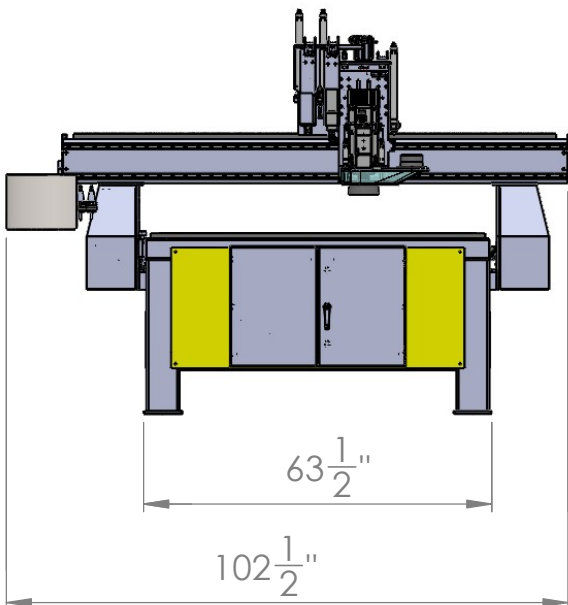

T2 T3 OPTIONS

- TANGENTIAL KNIFE
- LASER ENGRAVER
- VISION REGISTRATION

74" MAX HEIGHT

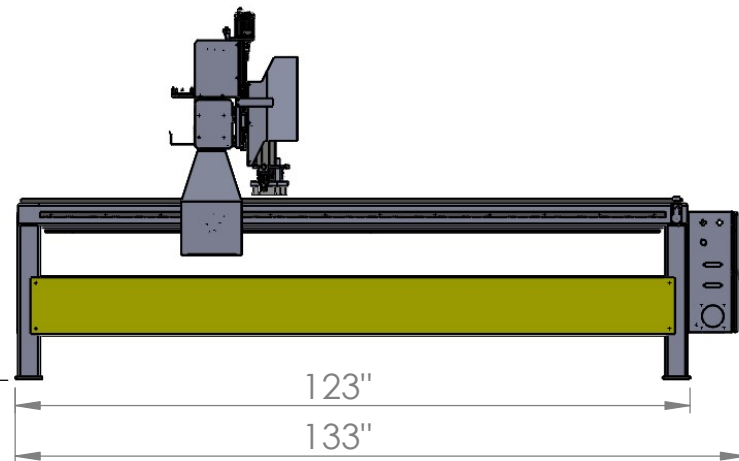

CAMaster

PART:
Panther 5 x 8 (PT-508)

CONFIGURATION: DWG Standard 58

DRAWING: Panther 5x8 Machine Layout

SCALE: 1:50

SHEET 1 OF 1