

PANTHER 4 x 8

STANDARD MACHINE

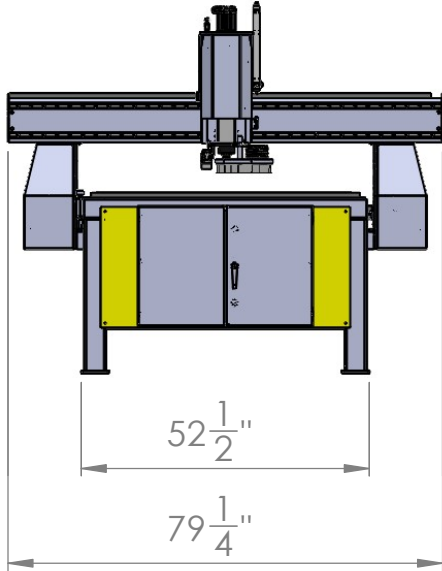

ATC MACHINE

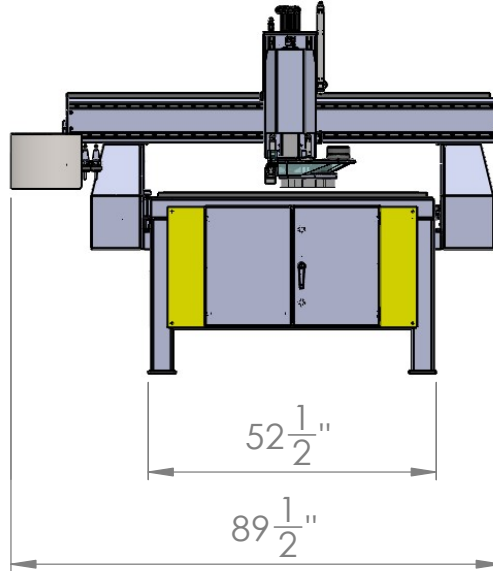

RECOIL MACHINE

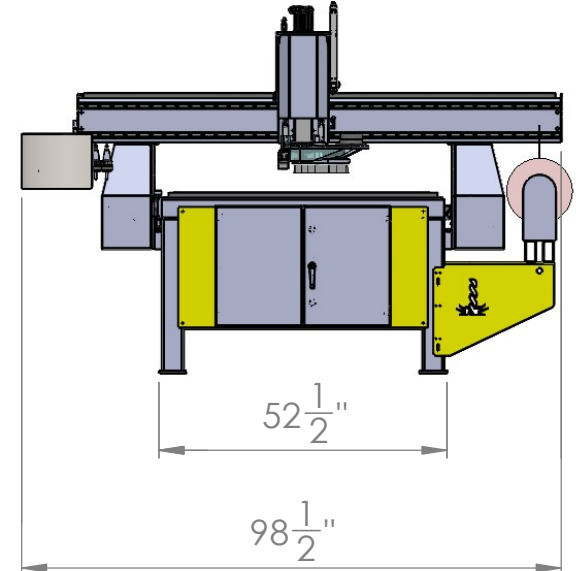

ATC + T2T3 MACHINE

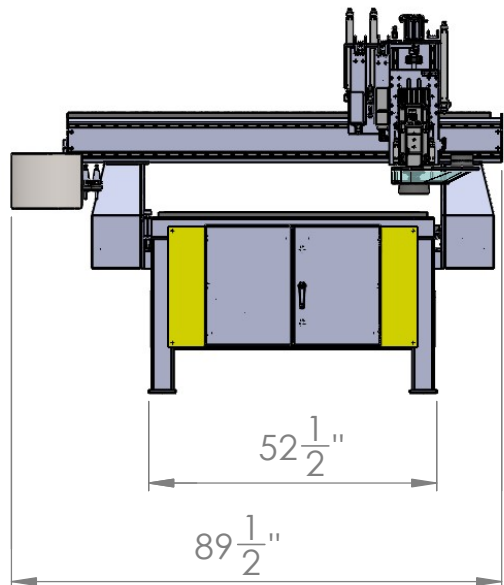

T2 T3 OPTIONS

- TANGENTIAL KNIFE
- LASER ENGRAVER
- VISION REGISTRATION

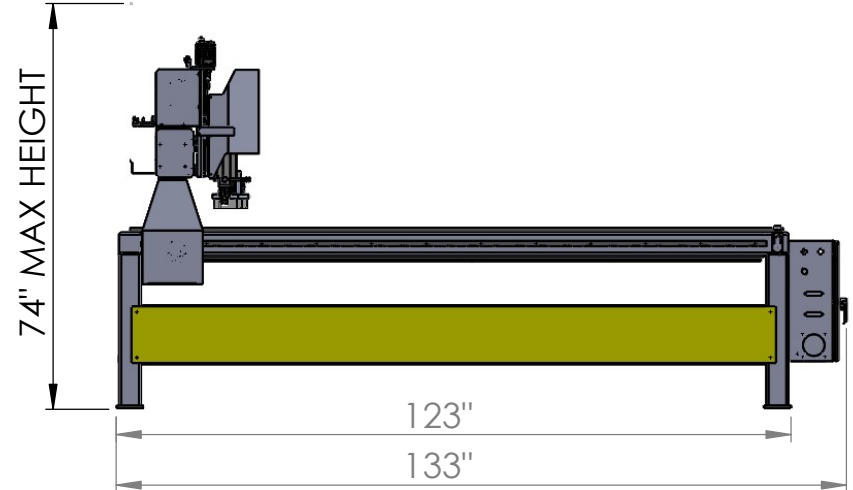

CAMaster

PART:
Panther 4 x 8 (PT-408)

CONFIGURATION: DWG Standard 48

DRAWING: Panther 4x8 Machine Layout