

# COBRA 6 X 12

**STANDARD MACHINE**

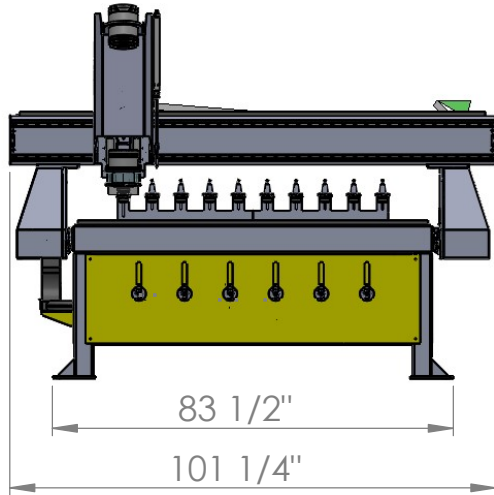

**ATC T2/T3 MACHINE**

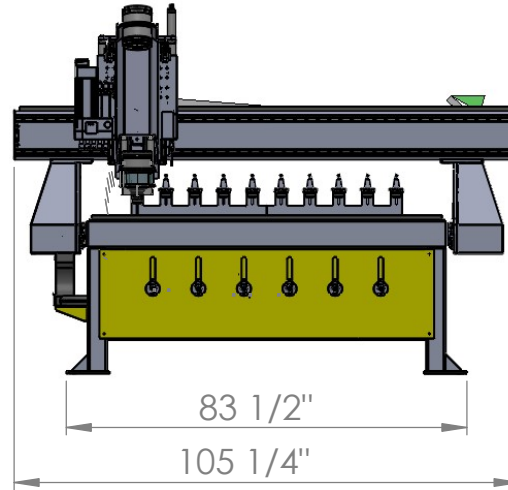

**ATC CAROUSEL MACHINE**

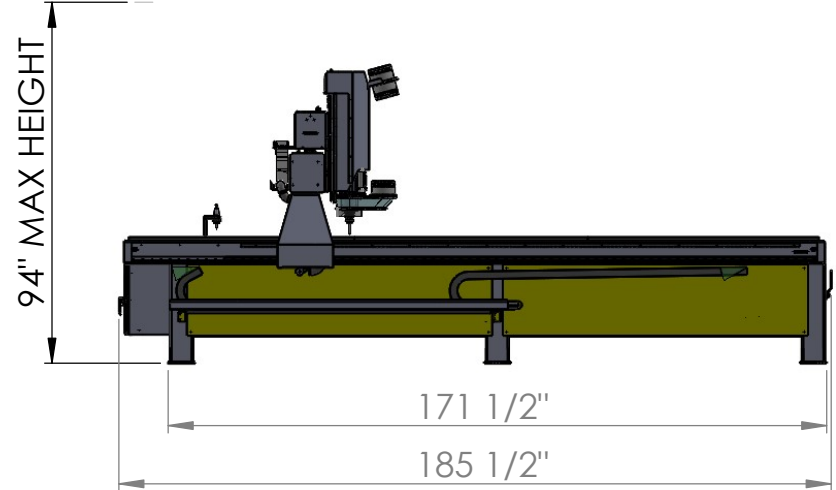
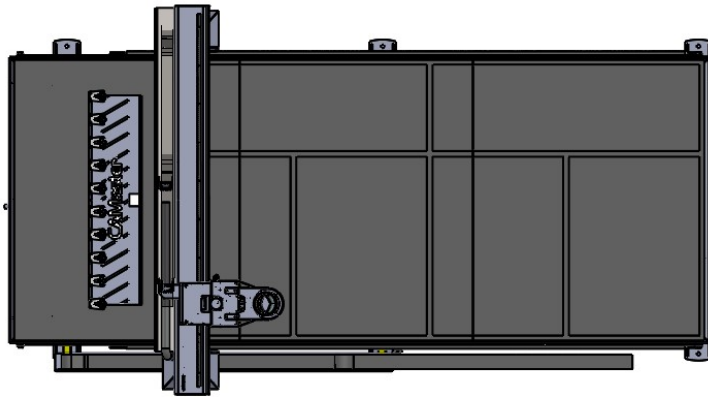
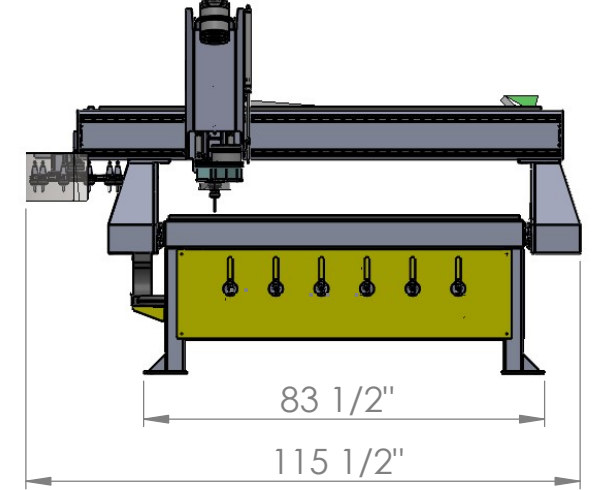

**T2/ T3 OPTIONS**

- DRILLBANK
- TANGENTIAL KNIFE
- VISION REGISTRATION

**CAMaster**

PART:  
Cobra 6 x 12 (CR-612)  
CONFIGURATION: Linear ATC 612  
DRAWING: Cobra 6x12 Machine Layout