

# COBRA 5 X 5

**STANDARD MACHINE**

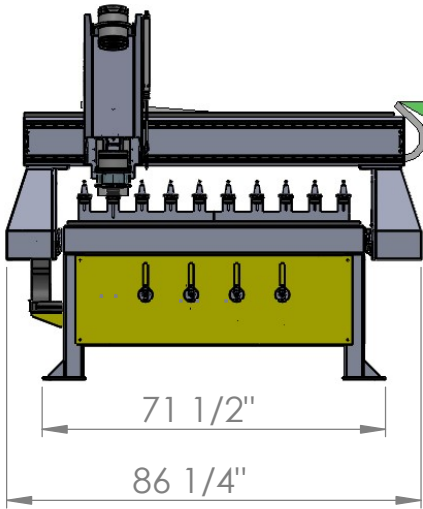

**ATC T2/T3 MACHINE**

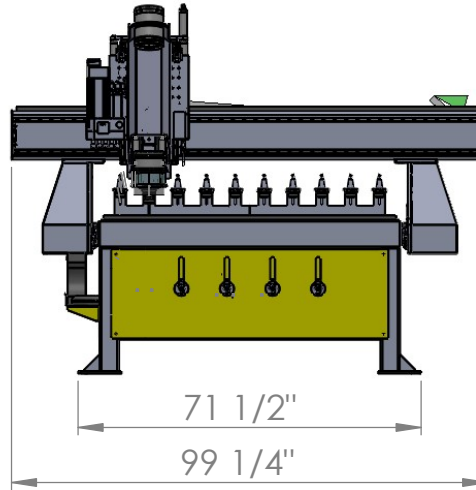

**ATC CAROUSEL MACHINE**

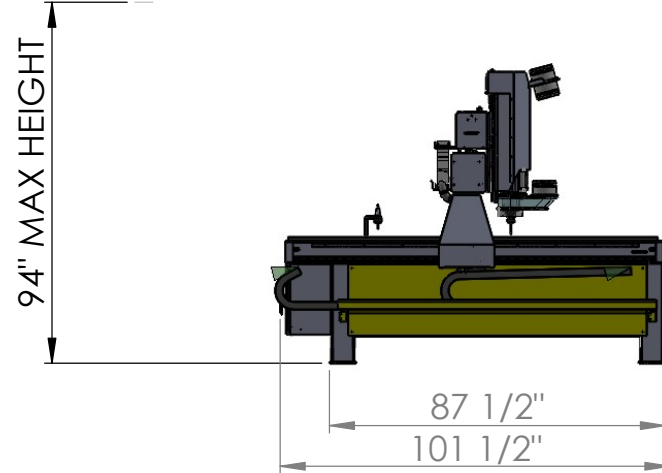
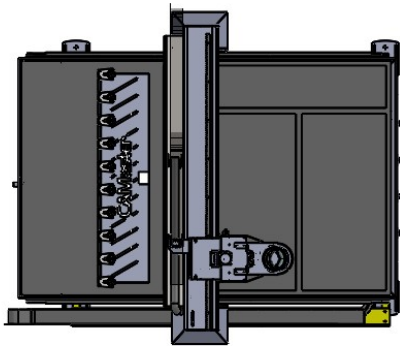
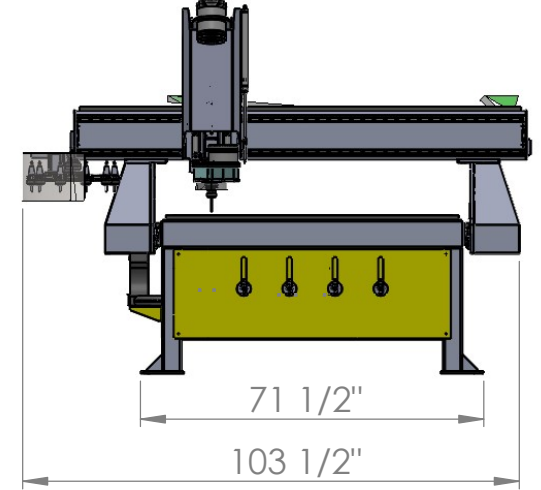

**T2/ T3 OPTIONS**

- DRILLBANK
- TANGENTIAL KNIFE
- VISION REGISTRATION

**CAMaster**

PART:  
Cobra 5 x 5 (CR-505)  
CONFIGURATION: Linear ATC 505  
DRAWING: Cobra 5x5 Machine Layout