

COBRA 5 X 12

STANDARD MACHINE

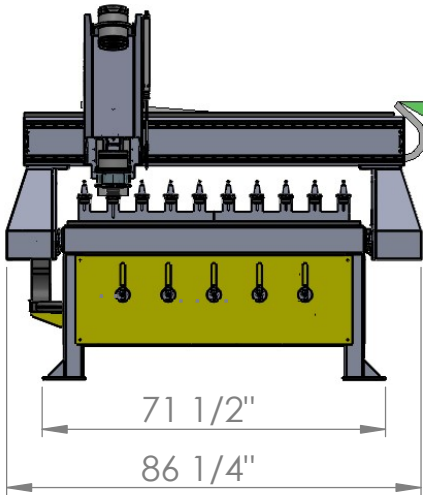

ATC T2/T3 MACHINE

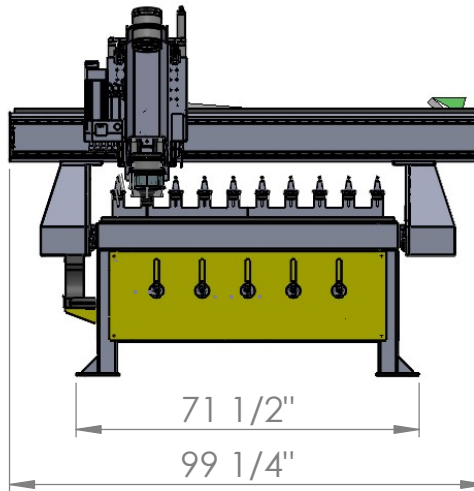

ATC CAROUSEL MACHINE

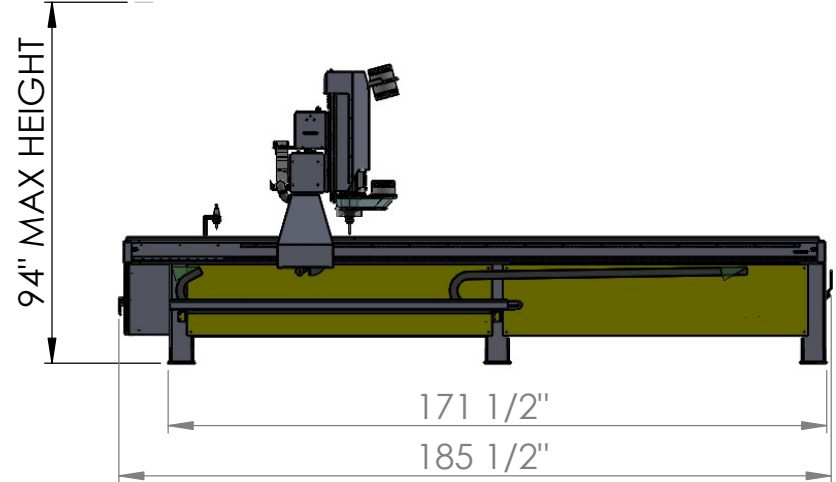
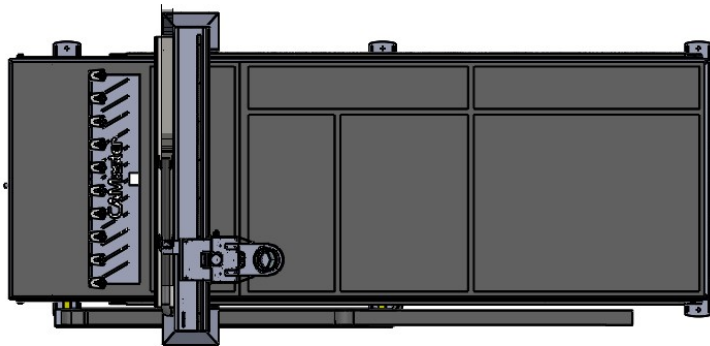
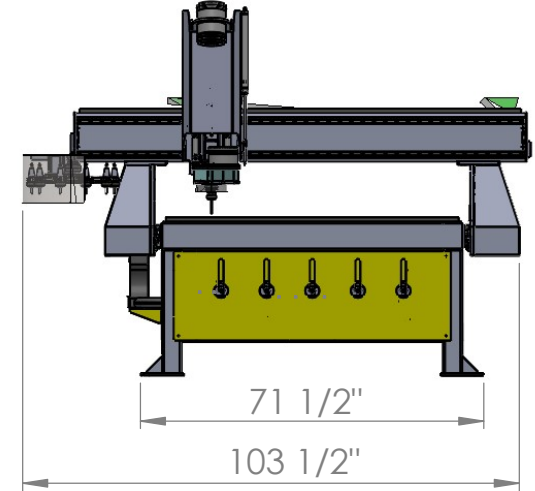

T2/ T3 OPTIONS

- DRILLBANK
- TANGENTIAL KNIFE
- VISION REGISTRATION

CAMaster

PART:
Cobra 5 x 12 (CR-512)
CONFIGURATION: Linear ATC 512
DRAWING: Cobra 5x12 Machine Layout